

## OLODUM RECESSED

**E10I0047-** -

base number      Color      BA Options  
 Temperature

- To build a product code in our configurator select the specify button on the base model # product page
- To build a manual product code on this datasheet choose from the options listed below in blue font and add the suffix to the base model #

### GENERAL

Series: Olodum  
 Brand: Side  
 Division: Exterior  
 Mounting Type: Recessed  
 Mounting Location: In-Ground  
 Subcategory: Drive Over

### PHYSICAL

Shape: Round  
 Diameter (mm): 220  
 Diameter (in): 8 11/16  
 Height (mm): 242  
 Height (in): 9 1/2  
 Light Distribution: Adjustable / Direct  
 Weight (kg): 3.8  
 Weight (lbs): 8.38  
 Diffuser: Clear tempered glass  
 Fixture Finish: SSS  
 Fixture Material: Aluminum Die Cast

### ELECTRICAL

Lamp Type: LED (Zhaga Standard)  
 Input Wattage (W): 20  
 Total Output Wattage (W): 17  
 Dimming: Non-Dimming / Phase Dimming (120vac Only)  
 Driver Included: Yes  
 Driver Location: Integrated  
 Driver Type: Constant Current - Universal  
 Driver Class: Class 2  
 Input Voltage (V): 120 - 277  
 Constant Current (MA): 500  
 Upon Request: (Not included - see components [IP65 or higher enclosure to be supplied by others]) Remote: 0-10Vdc dimming / (Included) Integral: Phase dimming @120Vac only / 277Vac

### LED

Color Temperature (°K): 3000 / 4000  
 Max. Delivered Lumen (lm): 2434.9 / 2607.5  
 Nominal Lumen (lm): 2750 / 2945  
 CRI: >80 CRI  
 Lamp Life (hrs): 50000

### OPTICAL

Reflector: Metallised polycarbonate reflector - Pivoting 350° and adjustable +/- 15° reflector  
 Optic: 15 / 45 / 65 / ASY

### RATINGS AND CERTIFICATIONS

Certified By: Certified for North American Standards  
 IP rating: IP67  
 IK Rating: IK10



3.80 kg / 8.38 lbs



PROJECT	
TYPE	
SPECIFIER	
QUANTITY	
DATE	

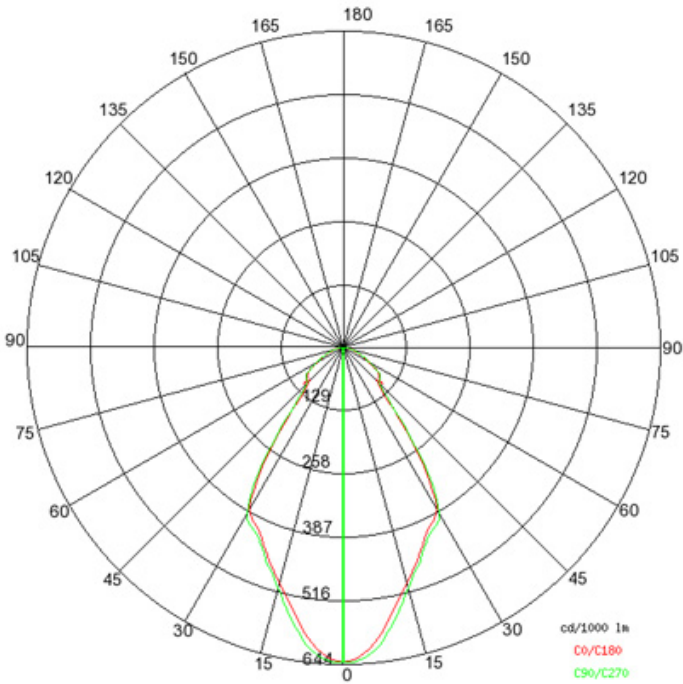

## OLODUM RECESSED

**E10I0059-** \_\_\_\_\_ - \_\_\_\_\_

base number      Color      BA Options  
 Temperature

- To build a product code in our configurator select the specify button on the base model # product page
- To build a manual product code on this datasheet choose from the options listed below in blue font and add the suffix to the base model #

### GENERAL

Series: Olodum  
 Brand: Side  
 Division: Exterior  
 Mounting Type: Recessed  
 Mounting Location: In-Ground  
 Subcategory: Uplight

### PHYSICAL

Shape: Round  
 Diameter (mm): 220  
 Diameter (in): 8 11/16  
 Height (mm): 242  
 Height (in): 9 1/2  
 Light Distribution: Adjustable / Direct  
 Weight (kg): 3.8  
 Weight (lbs): 8.38  
 Diffuser: Clear tempered glass  
 Gasket: Silicon rubber  
 Fixture Finish: SSS  
 Fixture Material: Aluminum Die Cast

### ELECTRICAL

Lamp Type: LED (Zhaga Standard)  
 Input Wattage (W): 20  
 Total Output Wattage (W): 17  
 Dimming: Tri-Mode (Non-Dimming and Phase Dimming (120Vac only) and 0-10V Dimming)  
 Driver Included: Yes  
 Driver Location: Integrated  
 Driver Type: Constant Current - Universal  
 Driver Class: Class 2  
 Input Voltage (V): 120 - 277  
 Constant Current (MA): 500  
 Upon Request: (Not included - see components [IP65 or higher enclosure to be supplied by others]) Remote: 0-10Vdc dimming / (Included) Integral: Phase dimming @120Vac only / 277Vac

### LED

Color Temperature (°K): 3000 / 4000  
 Max. Delivered Lumen (lm): 2434.9 / 2607.5  
 Nominal Lumen (lm): 2750 / 2945  
 CRI: >80 CRI  
 Lamp Life (hrs): 50000

### OPTICAL

Reflector: Polycarbonate metallized reflector  
 Optic: 15 / 45 / 65 / ASY

### RATINGS AND CERTIFICATIONS

Certified By: Certified for North American Standards  
 IP rating: IP67  
 IK Rating: IK10



3.80 kg / 8.38 lbs



PROJECT	
TYPE	
SPECIFIER	
QUANTITY	
DATE	

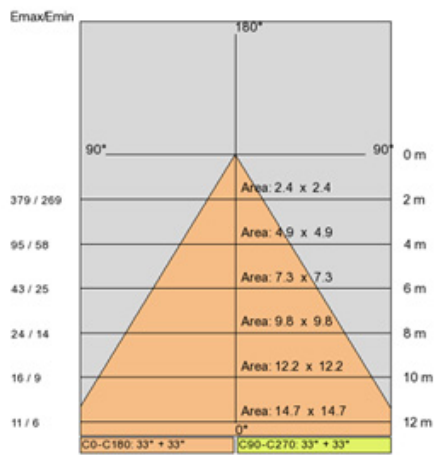
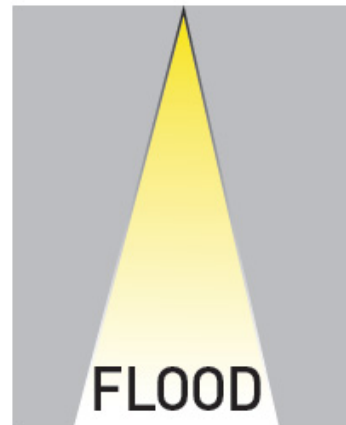

## OLODUM ROUND RECESSED

**E10I0071-** \_\_\_\_\_ - \_\_\_\_\_

base number      Color      BA Options  
 Temperature

- To build a product code in our configurator select the specify button on the base model # product page
- To build a manual product code on this datasheet choose from the options listed below in blue font and add the suffix to the base model #

### GENERAL

Series: Olodum  
 Subseries: Olodum Round  
 Brand: Side  
 Division: Exterior  
 Mounting Type: Recessed  
 Mounting Location: In-Ground  
 Subcategory: Uplight

### PHYSICAL

Shape: Round  
 Diameter (mm): 130  
 Diameter (in): 5 1/8  
 Height (mm): 146  
 Height (in): 5 3/4  
 Light Distribution: Adjustable / Direct  
 Weight (kg): 1.9  
 Weight (lbs): 4.19  
 Diffuser: Clear tempered glass  
 Gasket: Silicon rubber  
 Fixture Finish: SSS  
 Fixture Material: Aluminum Die Cast

### ELECTRICAL

Lamp Type: LED (Zhaga Standard)  
 Input Wattage (W): 6.8  
 Total Output Wattage (W): 5.8  
 Dimming: 0-10V Dimming / Phase Dimming (120Vac Only)  
 Driver Included: No  
 Driver Location: Remote  
 Driver Type: Constant Current - Universal  
 Input Voltage (V): 120 - 277  
 Constant Current (MA): 203  
 Upon Request: (Not included - see components [IP65 or higher enclosure to be supplied by others]) 0-10Vdc dimming / Phase dimming @120Vac only / 277Vac

### LED

Color Temperature (°K): 3000 / 4000  
 Max. Delivered Lumen (lm): 814.5 / 868.8  
 Nominal Lumen (lm): 1050 / 1120  
 CRI: >80 CRI  
 Lamp Life (hrs): 50000

### OPTICAL

Reflector: Metallized polycarbonate  
 Optic: 15 / 30 / 45  
 Adjustability: Rotational 350°; Tilt ±15°

### RATINGS AND CERTIFICATIONS

Certified By: Certified for North American Standards  
 IP rating: IP67  
 IK Rating: IK10

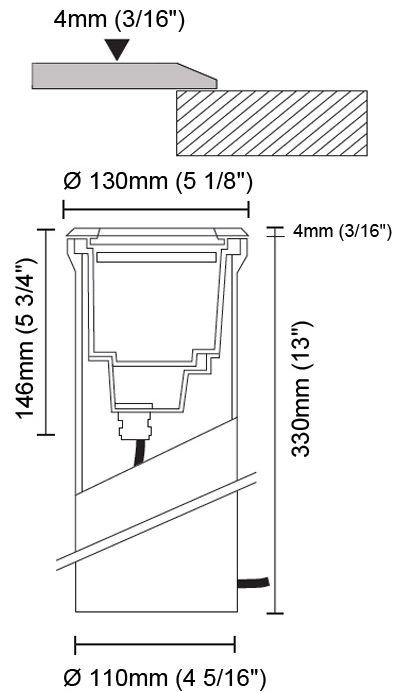

 1.9kg / 4.19lbs



## OLODUM ROUND RECESSED

E10I0071-

PROJECT	
TYPE	
SPECIFIER	
QUANTITY	
DATE	

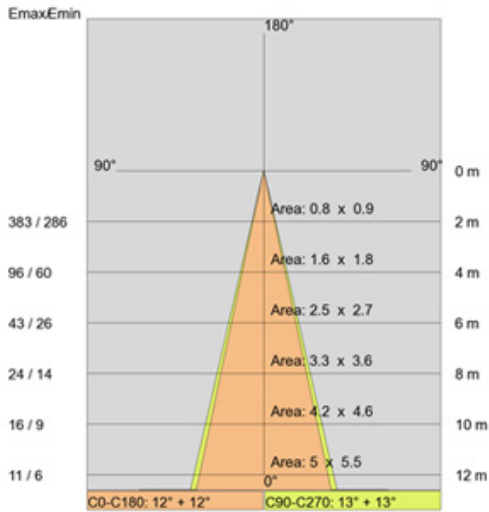
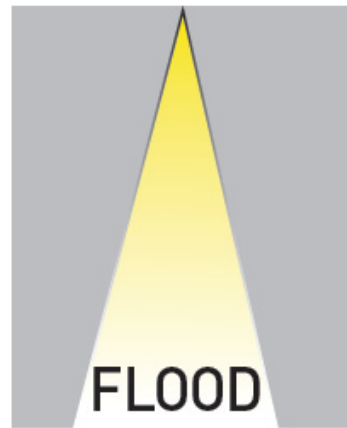
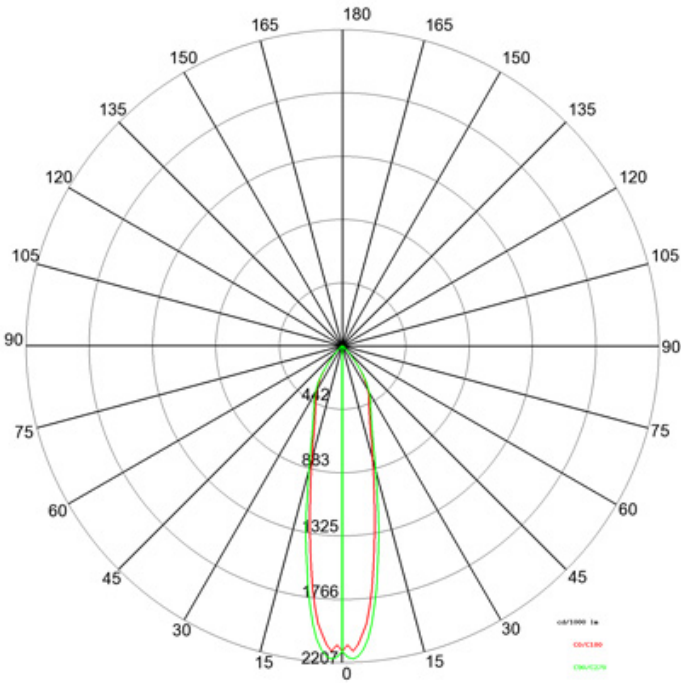

E

PROJECT	
TYPE	
SPECIFIER	
QUANTITY	
DATE	

## OLODUM RECESSED

**E10Q0040-** -

base number      Color      BA Options  
 Temperature

- To build a product code in our configurator select the specify button on the base model # product page
- To build a manual product code on this datasheet choose from the options listed below in blue font and add the suffix to the base model #

### GENERAL

Series: Olodum  
 Brand: Side  
 Division: Exterior  
 Mounting Type: Recessed  
 Mounting Location: Ceiling  
 Subcategory: Downlight

### PHYSICAL

Shape: Round  
 Diameter (mm): 220  
 Diameter (in): 8 11/16  
 Height (mm): 215  
 Height (in): 8 7/16  
 Light Distribution: Adjustable / Direct  
 Weight (kg): 3.6  
 Weight (lbs): 7.94  
 Diffuser: Clear tempered glass  
 Fixture Finish: SSS  
 Fixture Material: Aluminum Die Cast

### ELECTRICAL

Lamp Type: LED (Zhaga Standard)  
 Input Wattage (W): 20  
 Total Output Wattage (W): 17  
 Dimming: Tri-Mode (Non-Dimming and Phase Dimming (120Vac only) and 0-10V Dimming)  
 Driver Included: Yes  
 Driver Location: Integrated  
 Driver Type: Constant Current - Universal  
 Driver Class: Class 2  
 Input Voltage (V): 120 - 277  
 Constant Current (MA): 500  
 Upon Request: (Not included - see components [IP65 or higher enclosure to be supplied by others]) 0-10Vdc dimming / (Included) Integral: Phase dimming @120Vac only / 277Vac

### LED

Color Temperature (°K): 3000 / 4000  
 Max. Delivered Lumen (lm): 2434.9 / 2607.5  
 Nominal Lumen (lm): 2750 / 2945  
 CRI: >80 CRI  
 Lamp Life (hrs): 50000

### OPTICAL

Reflector: Polycarbonate metallized reflector  
 Optic: 15 / 45 / 65 / ASY

### RATINGS AND CERTIFICATIONS

Certified By: Certified for North American Standards  
 IP rating: IP67  
 IK Rating: IK10

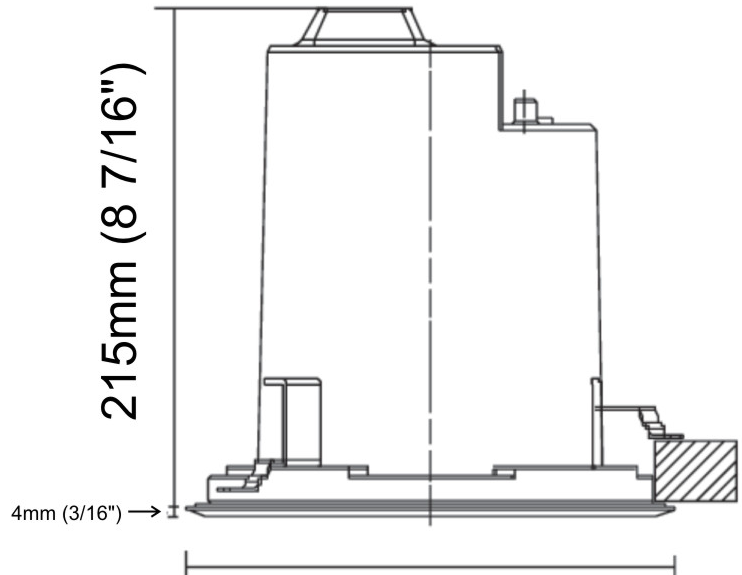

220mm (8 11/16")

Recessed Thickness 10 / 12.5 / 15 / 25 / 30 mm  
 (3/8" / 1/2" / 9/16" / 1" / 1 3/16")



201mm (7 15/16")  
 3.6kg / 7.93lbs

PROJECT	
TYPE	
SPECIFIER	
QUANTITY	
DATE	

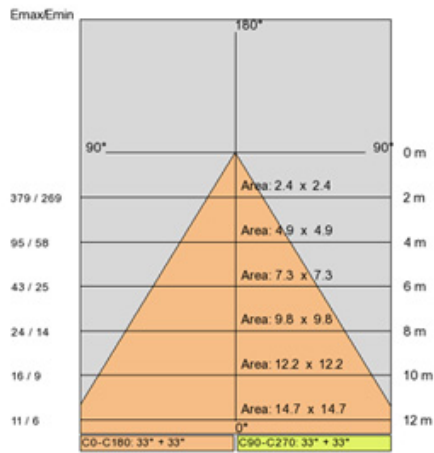
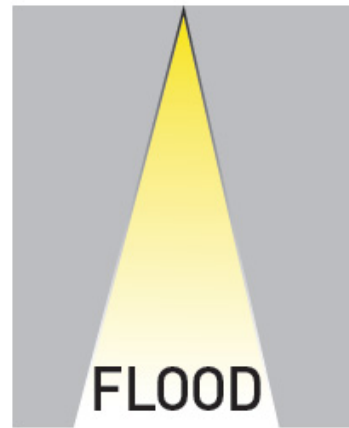
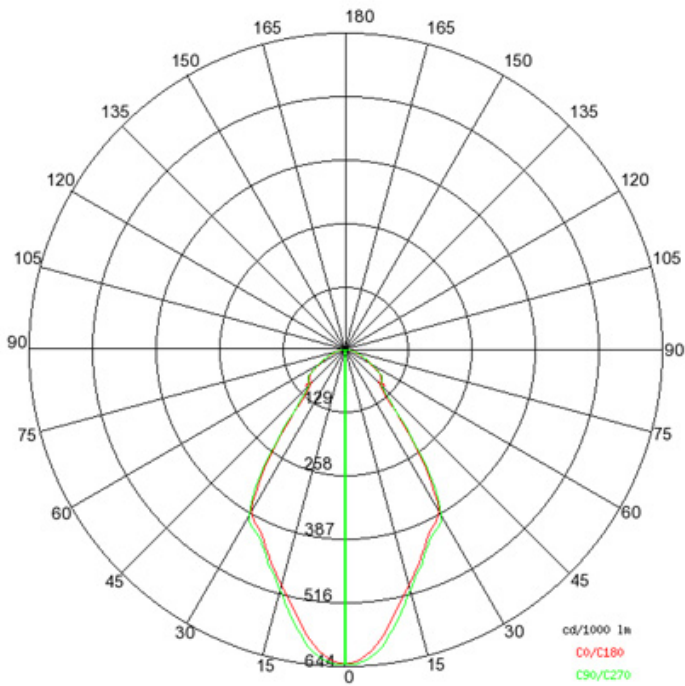



PROJECT	
TYPE	
SPECIFIER	
QUANTITY	
DATE	

## OLODUM RECESSED

**E10Q0046-** -

base number      Color      BA Options  
 Temperature

- To build a product code in our configurator select the specify button on the base model # product page
- To build a manual product code on this datasheet choose from the options listed below in blue font and add the suffix to the base model #

### GENERAL

Series: Olodum  
 Brand: Side  
 Division: Exterior  
 Mounting Type: Recessed  
 Mounting Location: Ceiling  
 Subcategory: Downlight

### PHYSICAL

Shape: Round  
 Diameter (mm): 220  
 Diameter (in): 8 11/16  
 Height (mm): 215  
 Height (in): 8 7/16  
 Light Distribution: Adjustable / Direct  
 Weight (kg): 3.6  
 Weight (lbs): 7.94  
 Diffuser: Clear tempered glass  
 Fixture Finish: SSS  
 Fixture Material: Aluminum Die Cast

### ELECTRICAL

Lamp Type: LED (Zhaga Standard)  
 Input Wattage (W): 20  
 Total Output Wattage (W): 17  
 Dimming: Tri-Mode (Non-Dimming and Phase Dimming (120Vac only) and 0-10V Dimming)  
 Driver Included: Yes  
 Driver Location: Integrated  
 Driver Type: Constant Current - Universal  
 Driver Class: Class 2  
 Input Voltage (V): 120 - 277  
 Constant Current (MA): 500  
 Upon Request: (Not included - see components [IP65 or higher enclosure to be supplied by others]) 0-10Vdc dimming / (Included) Integral: Phase dimming @120Vac only / 277Vac

### LED

Color Temperature (°K): 3000 / 4000  
 Max. Delivered Lumen (lm): 2434.9 / 2587.5  
 Nominal Lumen (lm): 2750 / 2945  
 CRI: >80 CRI  
 Lamp Life (hrs): 50000

### OPTICAL

Reflector: Polycarbonate metallized reflector  
 Beam Angle: Spot - 15° / Flood - 45° / Wide Flood - 65° / Asymmetric

### RATINGS AND CERTIFICATIONS

Certified By: Certified for North American Standards  
 IP rating: IP67  
 IK Rating: IK10

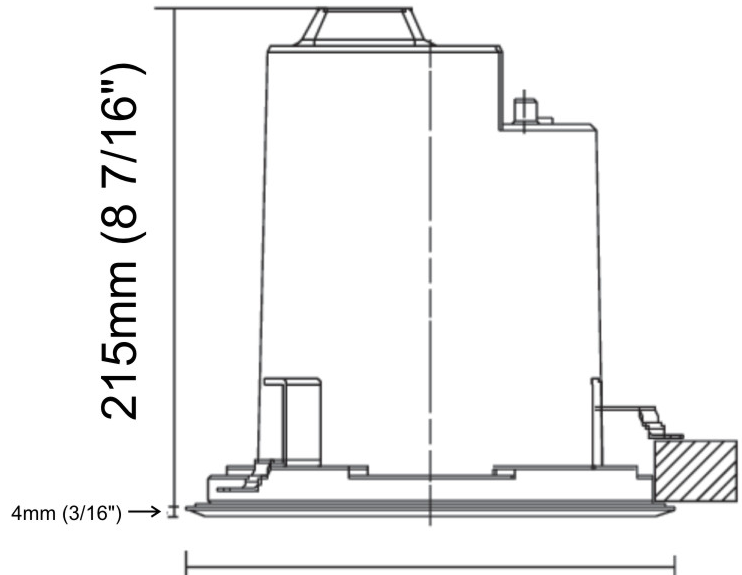

220mm (8 11/16")

Recessed Thickness 10 / 12.5 / 15 / 25 / 30 mm  
 (3/8" / 1/2" / 9/16" / 1" / 1 3/16")



201mm (7 15/16")  
 3.6kg / 7.93lbs

PROJECT	
TYPE	
SPECIFIER	
QUANTITY	
DATE	



PROJECT

TYPE

SPECIFIER

QUANTITY

DATE

#### Fixture Finish

Satined Stainless Steel - SSS



**Digital:** Not all screens are calibrated the same, and therefore, colors will appear differently between screens.

**Physical:** When texture is involved, there will be variations in color, character and tone within a product series and between product families.



PROJECT	
TYPE	
SPECIFIER	
QUANTITY	
DATE	

### LEGEND

floor-mounted	pivotal	special LED (upon request) RGB, RGBW, tunable, gold+, meat+, art+, fashion+
wall and ceiling: recessed and surface mounted	rotating	warm dim / natural dimming LED
ceiling-mounted and wall-mounted	illuminate tilted	rechargeable battery powered
wall-mounted	color of suspension cable	fixture with natural vivid LED (upon request)
omni-directional light distribution	length of suspension cable	color rendering index
direct light distribution	reflector degree selection	color temperature
direct/indirect light distribution	super spot	lumen (luminous flux)
indirect light distribution	lens	efficacy (lumens per watt)
asymmetric light distribution	lens pack	Unified Glare Rating (UGR) range from 5-40
aura light distribution	shine ring	marine grade (AISI 316 stainless steel)
round wall or ceiling cut-out	integrated shine ring with diffuser	walk on
square wall or ceiling cut-out	free individual colors 01-29	drive on
the supplied jig specifies the cutout dimensions	individual colors: 00 (free of charge), 01-25 (extra charge)	Dark Sky Compliance
minimum distance (meters) lamp - object	luminaire part to be colored (F1)	Americans with Disabilities Act (less than 4" off the wall located between 27"-84" from floor)
recessed depth	luminaire part to be colored (F2)	lamp protected against explosion
ceiling thickness in mm	luminaire part to be colored (F3)	blown glass using traditional methods by master glass blower
ceiling thickness selection	luminaire part to be colored (F4)	acoustic material
dimmable DP (phase), DV (0-10V), DD (dali), DS (step-dim)	luminaire part to be colored (F5)	protection class I, protection insulation
included or excluded LED driver/transformer/control gear	color of 3-circuit adaptor	protection class II, protection insulation
separately switchable	indirect diffuser	ETL Certified to UL and CSA Standards
sensor	direct diffuser	UL Certified to UL and CSA Standards
remote control	ball-proof (upon request)	CSA Certified to UL and CSA Standards
available upon request	accessory	Certified for North American Standards

### IP RATING

IP20	protected against ingress of solid bodies greater than 12.5mm (finger)
IP33	protected against ingress of solid bodies greater than 2.5mm protected against sprays of water up to 60 degrees from the vertical (rain)
IP40	protected against ingress of solid bodies greater than 1mm (wire) no protection against the ingress of moisture
IP43	protected against ingress of solid bodies greater than 1mm (wire) protected against sprays of water up to 60 degrees from the vertical (rain)
IP44	protected against ingress of solid bodies greater than 1mm (wire) protected against water splashed from all directions
IP54	protected against limited ingress of dust (wet rooms/covered outdoor areas) protected against water splashed from all directions
IP65	protected against ingress of dust protected against jets of water
IP66	protected against ingress of dust protected against powerful jets of water or heavy seas
IP67	protected against ingress of dust protected against immersion of water between 15cm - 1m for 30 minutes
IP68	protected against ingress of dust protected against immersion of water under pressure for long periods

### IK RATING

IK01	protected against 0.14 joules impact (equivalent to 0.25kg mass dropped from 56mm above the surface)
IK02	protected against 0.2 joules impact (equivalent to 0.25kg mass dropped from 80mm above the surface)
IK03	protected against 0.35 joules impact (equivalent to 0.25kg mass dropped from 140mm above the surface)
IK04	protected against 0.5 joules impact (equivalent to 0.25kg mass dropped from 200mm above the surface)
IK05	protected against 0.7 joules impact (equivalent to 0.25kg mass dropped from 280mm above the surface)
IK06	protected against 1 joules impact (equivalent to 0.25kg mass dropped from 400mm above the surface)
IK07	protected against 2 joules impact (equivalent to 0.5kg mass dropped from 400mm above the surface)
IK08	protected against 5 joules impact (equivalent to 1.7kg mass dropped from 300mm above the surface)
IK09	protected against 10 joules impact (equivalent to 5.0kg mass dropped from 200mm above the surface)
IK10	protected against 20 joules impact (equivalent to 5.0kg mass dropped from 400mm above the surface)